

COMPANY PROFILE

2025



UAS PILLS



2014

FOUNDATION



70

EMPLOYEES

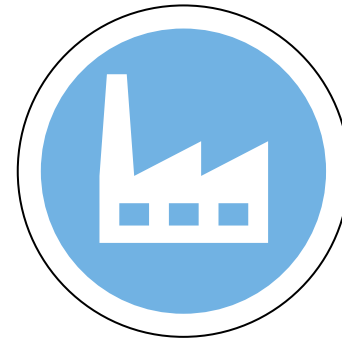

3000mq

FACILITY PLANT



13

ACTIVE PROGRAMS

CUSTOMERS

GERMANY



CANADA

THALES

ITALY



CZECH REPUBLIC

CHARVÁT
AXL, a.s.

SOUTH KOREA



국방과학연구소
Agency for Defense Development



TURKEY



UNITED ARAB EMIRATES



DIRGANTARA INDONESIA
INDONESIAN AEROSPACE (IAe)

INDONESIA

OUR ADDED VALUE

UAS added value & differentiator consists in the capability of providing valuable contribution since the conceptual stage **in each of the design & development phases** taking **responsibility of the results**. UAS Engineers expertise is built in several **Aircraft programs** worldwide and thorough **aviation knowledge**

Our team is able to support an **integrated approach** covering the entire product development life cycle according to ARP 4754 guidelines.

Product Development Process & Organization

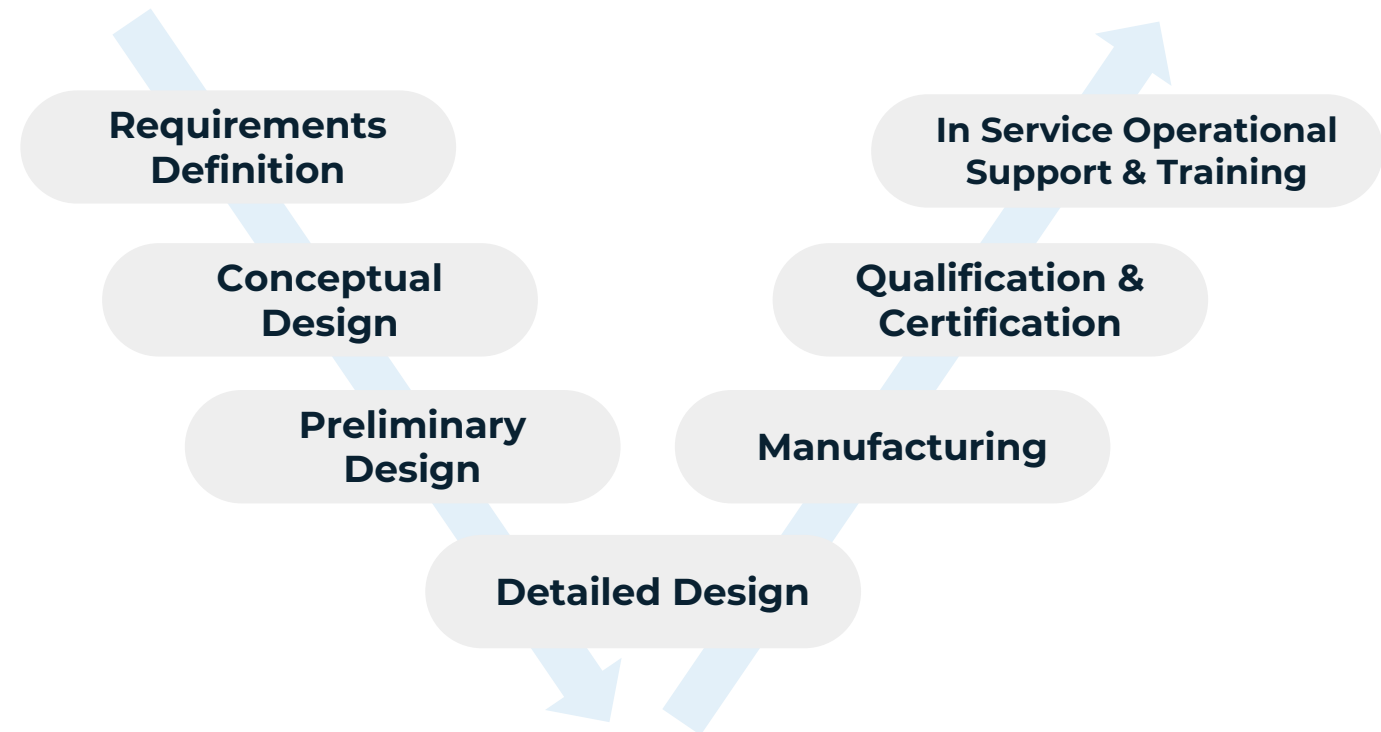

OUR PROCESSES

1 – ENGINEERING DESIGN

3D mechanical design, hydraulic, electronic design (DO254) and SW coding (DO178), combined with performance, reliability and safety analysis (ARP4761).

2 – QUALIFICATION & CERTIFICATION

Performance, endurance, fatigue, environmental and EMI/EMC tests in compliance with RTCA-DO160 and MIL-STD-810.

Bespoke test benches design and manufacturing, qualification procedures and test reports.

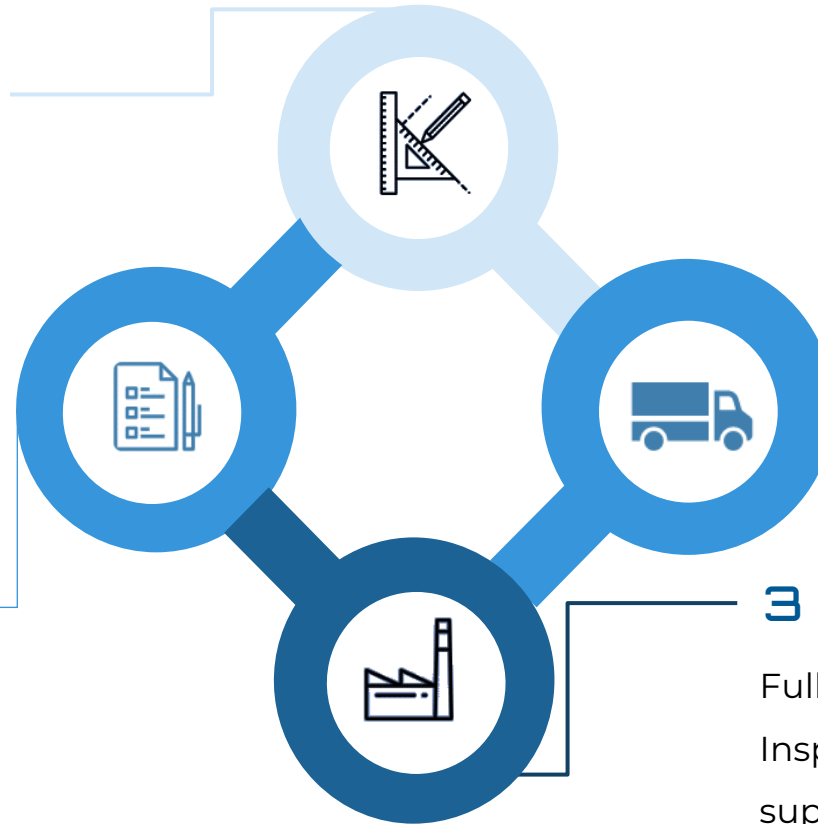

4 – LOGISTIC SUPPORT

We take care of the maintenance, repair and replacement of the products we supply to our customers. Warehouse storage and ready to ship services.

3 – MANUFACTURING & QUALITY

Fully traceable serialized products, First Article Inspection Report, Certificate of Conformity, Sub-supplier management, obsolescence monitoring, hazardous materials monitoring, critical parts management. Assembly, acceptance tests and quality inspection.

Supply chain management & testing. In compliance with EN9100.

APPLICATIONS: Civil Programs



Tilt Rotor



Commuter



Business Jet

APPLICATIONS: Military Programs



UAV



Fighter Jet



Military
Trainers



Military Helicopters

APPLICATIONS: Advanced Air Mobility

UAS is well engaged also in the Advanced Air Mobility market and has several ongoing discussion with different Manufacturers;



Actuation Systems

- Electromechanical system for Landing Gear
- Wheel Braking System
- Nose Wheel System

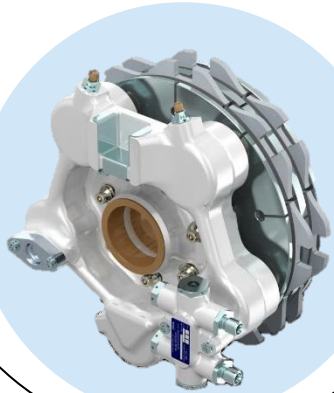

Electro mechanical Actuators

- Linear, Rotary and SMART Actuators
- Mechanically and Electronically Redundant Electromechanical Actuators
- Low/HIGH power Electromechanical Actuators

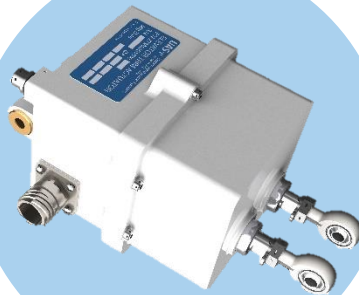

Hydraulic System

- Power generation and Hydraulic Power Management System (Pumps, Filter, valves etc.)
- Hydraulic Actuation System



Electronic Control Units

- Remote Sensor Acquisition electronics (Remote Electronic Unit)
- Remote Primary Actuation Control Electronics (Remote Control Unit)

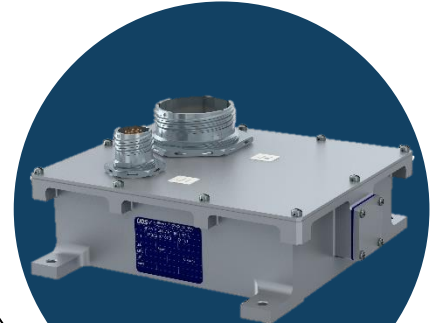

Actuation System



Wheel Brake
Assembly



Main Wheel
Assembly

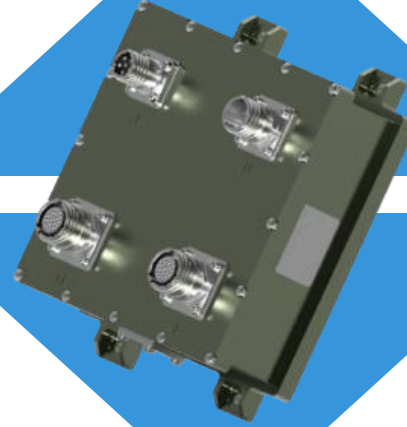

Brake Control
Unit

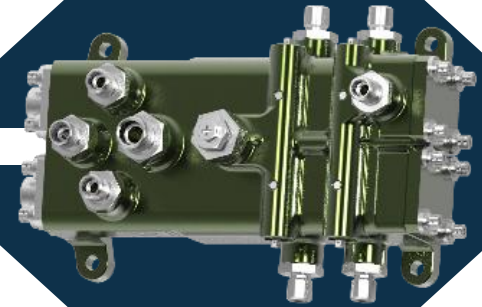

Brake Meter
Unit

Complete brakes systems composed by wheels, brakes and corresponding controls including electronic control units, embedded software and antiskid according to ARP1070.

Brake system architectures according to Customer requirements: e.g., electromechanics or hydraulic brake-by-wire systems.

The maximum Design Assurance Level (DAL A) achievable by our systems. Full collaboration during ground testing of the aircraft.

Electromechanical Actuators

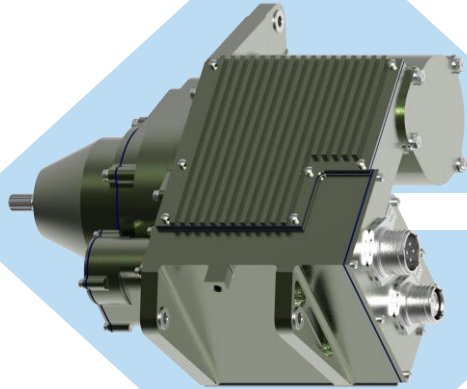

Flap Control Unit

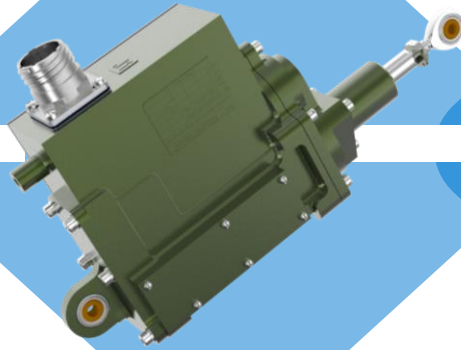

Lateral-Directional
Trim Actuator

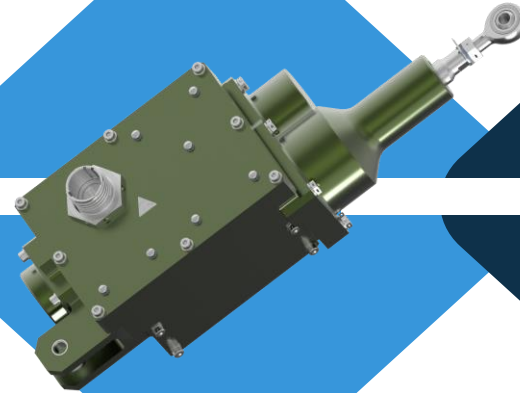

Bypass Door
Actuator

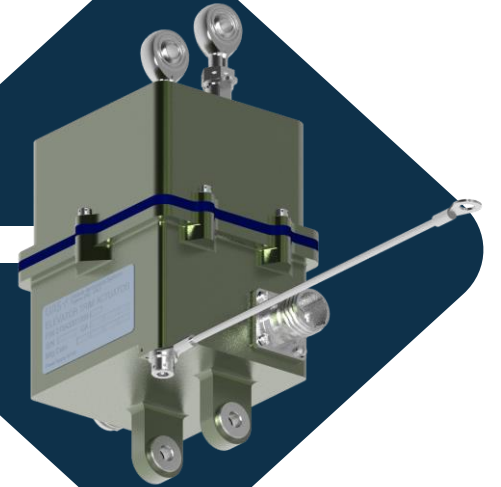

Elevator Trim
Actuator

Complete flap systems including pilot command, electronic control unit, power drive unit, transmission shafts, screwjack and asymmetry sensors. Smart Electromechanical Actuators with integrated electronic control unit and embedded software (up to DAL A). Redundant architectures with double brushless motors and up to triplex position sensors, clutch-declutch, torque limiter and end stroke devices.

Hydraulic System

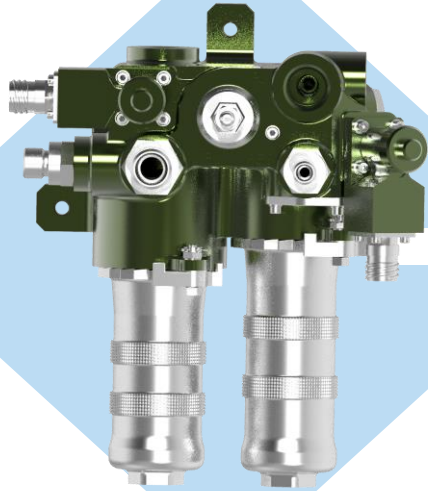

Hydraulic Filter



Hydraulic Reservoir

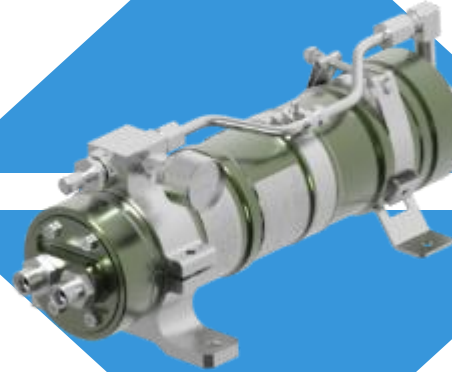

Hydraulic Accumulator



Engine Driven Pump

Complete Hydraulic Power Systems: Bootstrap Reservoirs, Filter Packages, Accumulators and Hydraulic Pumps.

Electronic Control Units



Remote
Electronic Unit

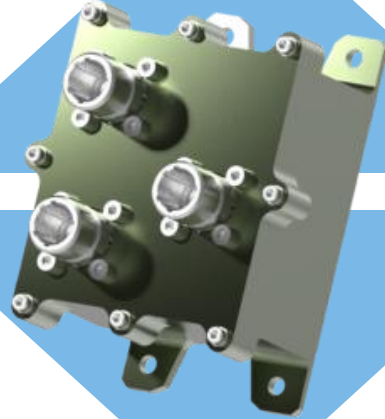

Collective Head
Interface Unit



Electric brake
Control Unit

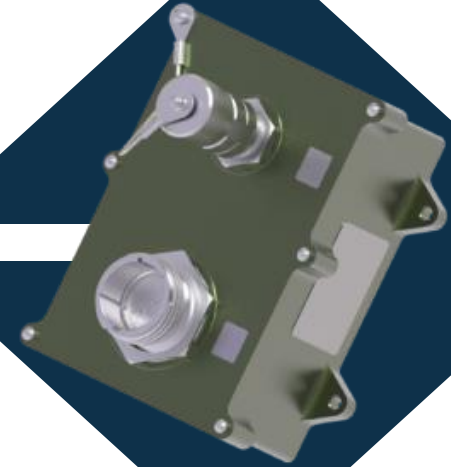

Speedbrake
Control Unit

Electronic Control Units design and production. HW design, prototyping, qualification testing and production. Firmware and application SW coding with independent validation and verification process to assure the highest level of safety required.

QUALIFICATION & CERTIFICATION

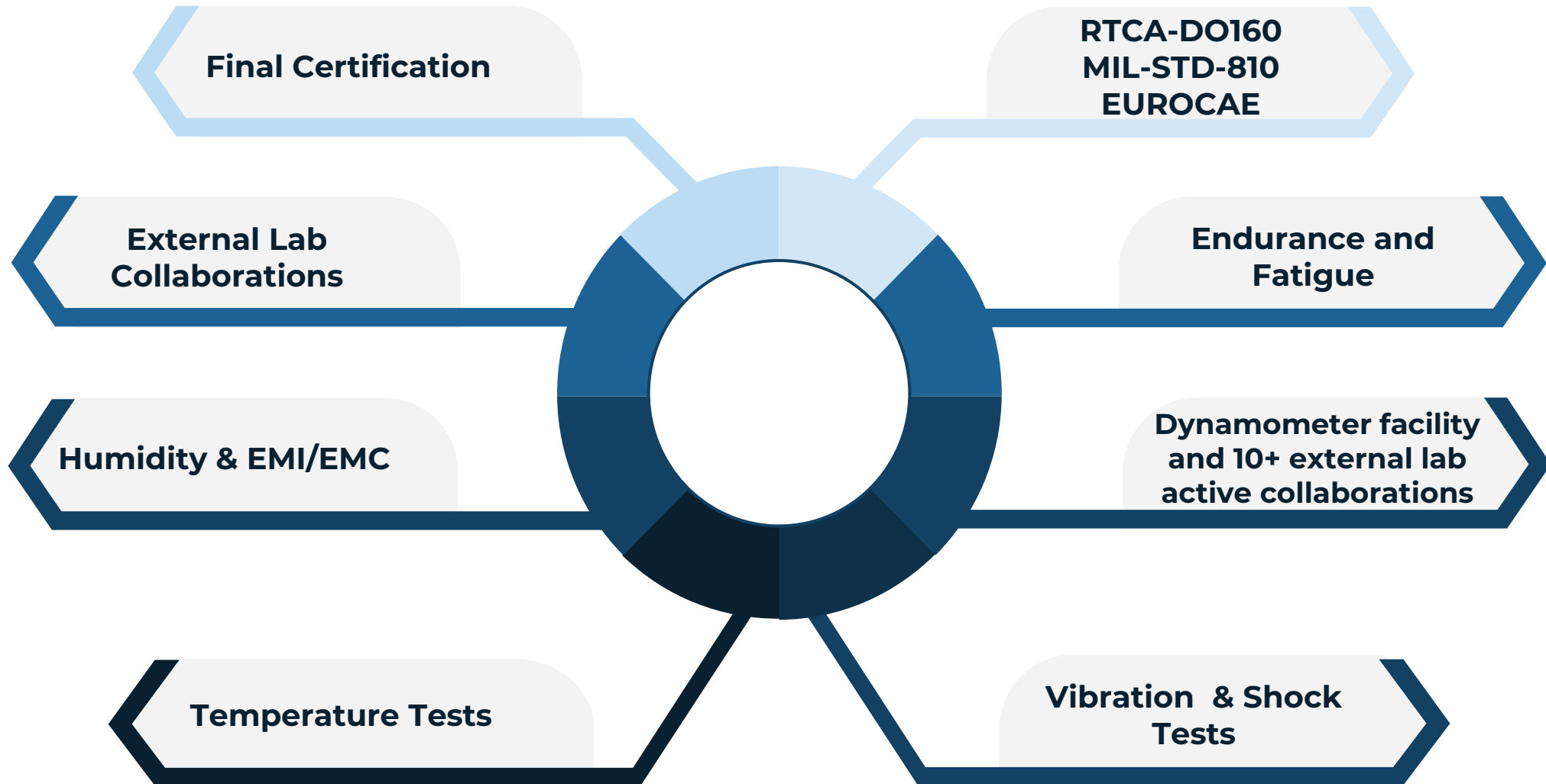

PRODUCTION TEST BENCH

Hydraulic bench

Qualification. Climatic Chambers for extreme temperature



Qualification vibration test system



Qualification impulse test hydraulic bench

MANUFACTURING & QUALITY

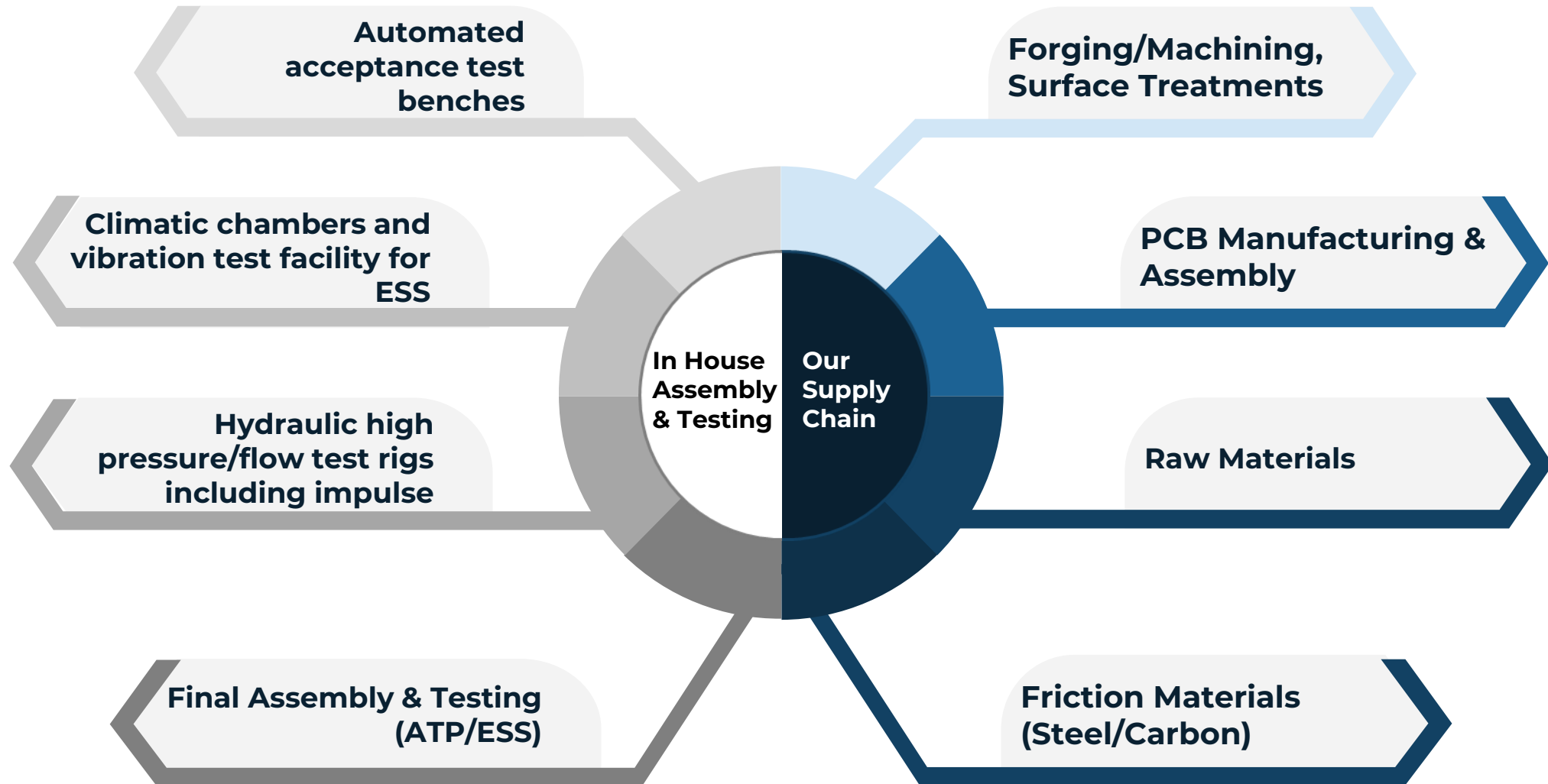

QUALITY

QUALITY - A CORPORATE FOCUS

The implementation of aeronautical systems is a PROCESS in which quality is a fundamental requirement to guarantee the reliability of the design and final product. UAS Quality Management System supports all the necessary certifications required to be able to meet the needs of international markets in both the civil and military sectors.

Our quality system complies with:

- **EN 9100:2018**
- **UNI EN ISO 9001:2015**
- **Experienced in POA Part 21G**



WHERE WE ARE

Via Bufaloro, 21
06089 Torgiano (PG)
ITALY

Website: www.uas-group.com

Email: sales@uas-group.com

Tel: 075 988 8222



Your Reliable & Agile Partner for Aerospace Innovative & Complex Systems

FOLLOW US ON...

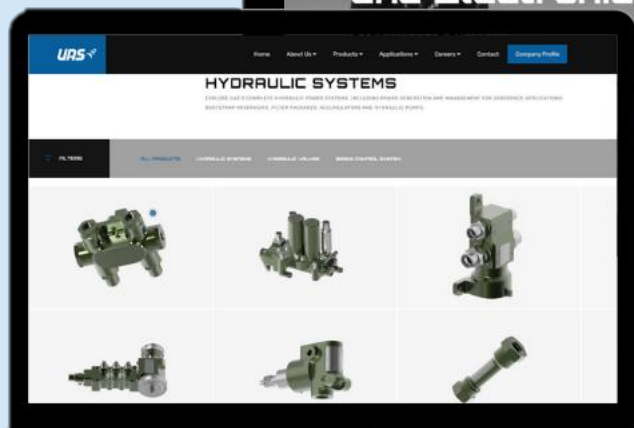
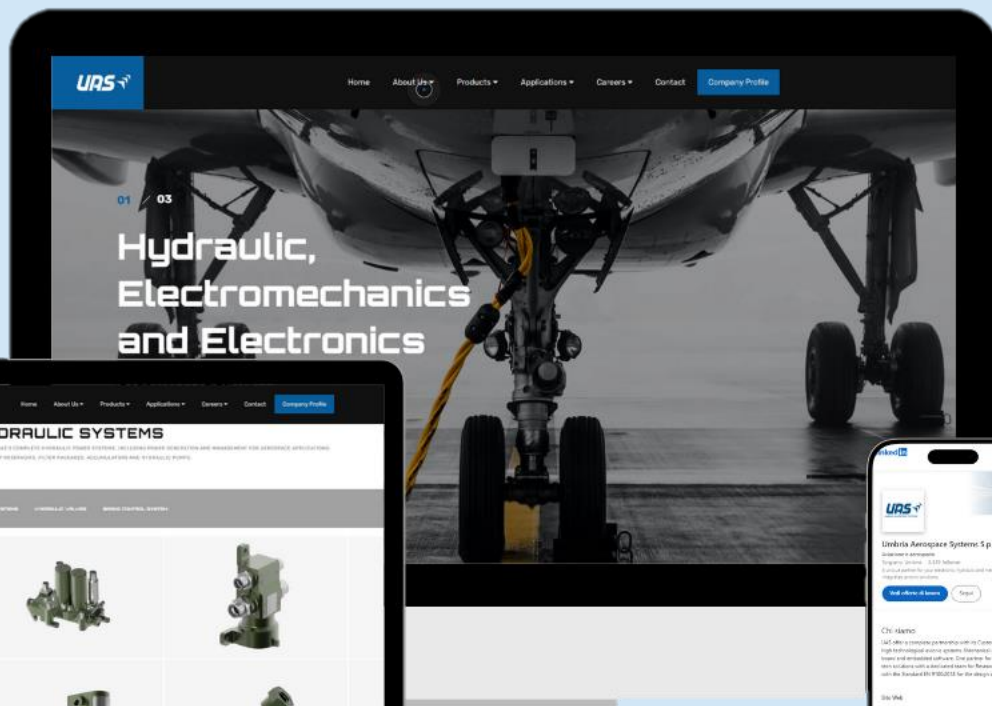

Umbria Aerospace Systems S.p.A
<https://www.uas-group.com>



Umbria Aerospace Systems S.p.A
<https://www.linkedin.com>



sales@uas-group.com